



Research Article

LINEAR ANTENNA ARRAY ADAPTIVE BEAMFORMING FOR SPACE-TIME SIGNAL PROCESSING USING HYBRID GENETIC ALGORITHMS APPLIED TO FADING CHANNELS

Joyanto Roychoudhary., Neeraj Kumar and Pushpendu Kanjilal

Department of Electronics and Communication Engineering, B.P. Poddar Institute of Management and Technology
137, V.I. P.Road, PoddarVihar, Kol-700032, India

ARTICLE INFO

Article History:

Received 7th April, 2018

Received in revised form 16th

May, 2018 Accepted 3rd June, 2018

Published online 28th July, 2018

Key words:

Application, Traffic, domain, BWA, smart, adaptive, beamforming

ABSTRACT

In Today's World, the Wireless Community is in great demand of Increasing capacity and to provide high data rate services due to increase in the number of users and traffic due to a paradigm shift in the existing technology to support Internet Application domain due to the increased popularity of Broadband Wireless Access (BWA). The 2.4 GHz licenced band caters to a variety of applications and 5850-5925 MHz for Automotive Radar Applications. Smart Antenna Arrays here are finding wide popularity in the EM community because they have a potential to provide both high capacity by dynamically tuning Interference in real time Environment (automotive motion, aerodynamics) by adjusting the weights, separations as well as appropriate phases and have potential applications in spacial Signal processing such as DOA estimation, adaptive beamforming and other DSP applications. The ability to adapt the radiation pattern (sidelobe, main beam direction, nulls, beamwidth) have been studied in this paper.

Copyright©2018 Joyanto Roychoudhary., Neeraj Kumar and Pushpendu Kanjilal. This is an open access article distributed under the Creative Commons Attribution License, which permits unrestricted use, distribution, and reproduction in any medium, provided the original work is properly cited.

INTRODUCTION

ST Space Time signal processing application is discussed here. ST signal processing is a method where in multiple Antennas are used both at the transmitter and receiver to achieve diversity both in the spacial and temporal domain with other precoding techniques. MU-MIMO with OFDM modulation is a very promising technology nowadays in ST signal processing due to its increased capacity and increased number of users for both Mobile and fixed Wireless services to spread the Application domain.

Nevertheless, channel estimation techniques have been widely used with other precoding techniques to predict the transmission of data in both certainty and Uncertainty of channel conditions. Operating on multiple sensory signals a ST signal processing receiver operates on the signals in both time and space to Improve QOS and Interference suppression.

For this a specified Antenna array geometry (Linear Array) based on the DOA estimation and beamforming is taken as a reference. In adaptive antennas, signals arriving at the elements for multiple sources is combined to estimate the Direction of Arrival(DOA). Based on the above estimate the element weights are tuned to minimize a cost function and to satisfy different constraints.

Make sure not to impose a large number of constraints since it will reduce the degree of freedom. Suppose we put a constraint of fixed length N of the Array. Since the length is fixed, now if we increase the degree of freedom or the number of elements, in order to accommodate such large number of elements the separation between the elements which has been kept as 0.5λ to reduce mutual coupling effects for this problem domain will reduce which is not expected.

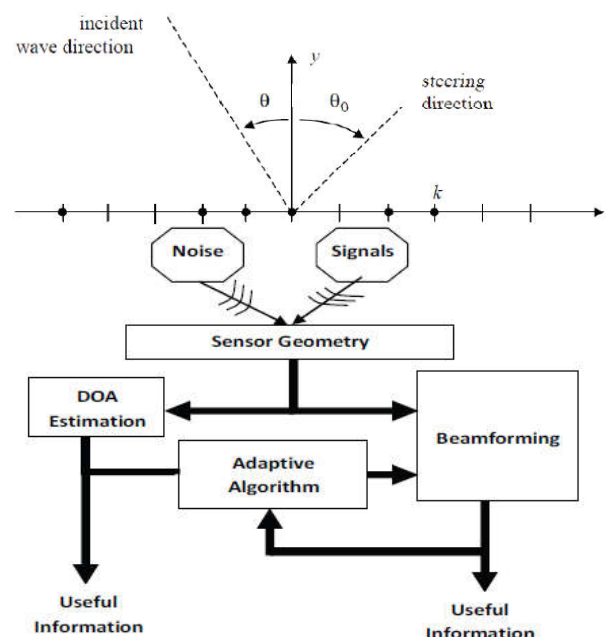

*Corresponding author: Joyanto Roychoudhary
Department of Electronics and Communication Engineering,
B.P. Poddar Institute of Management and Technology
137, V.I. P.Road, PoddarVihar, Kol-700032, India

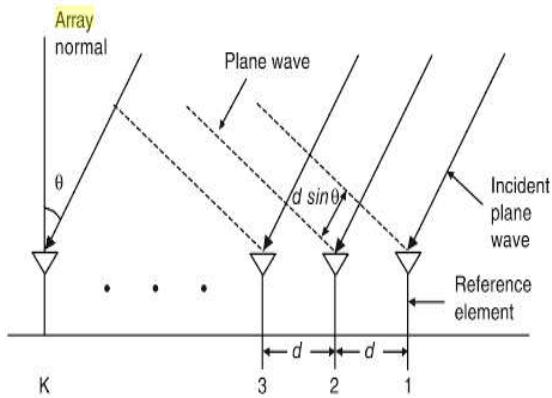

Fig 1 (a) Linear Antenna Array Geometry. (b) Smart Antenna Array model. (c) Plane wave incident on ULA at an AOA of theta.

So we will have to decrease the degree of freedom to cater to the fixed length of the array. The Linear array geometry and block diagram of Smart Antenna system is given in Fig.1.

Fig.1.(a)Linear Antenna Array Geometry. (b) Smart Antenna Array model. (c) Plane wave incident on ULA at an AOA of theta. Since the plane waves shown in fig. 1 travels a long distance to reach the 1st element of the array the plane wave gets time delayed while propagating to the n+1th element since the far field assumptions are no longer valid. So a time delayed version of the plane wave is received at the n+1th element.

$$\tau = dsin(\theta)/velocity\ of\ light$$

The time delay introduces a phase shift in the propagative plane wave and thus the array vector $a(\theta)$ can be formulated using the above parameters such as delay, phase, array geometry, AOA, signal frequency.

$$a(\theta_i) = \left[1, \exp\left(\frac{2\pi d \sin \theta_i}{\lambda}\right), \dots, \exp\left(\frac{2\pi d(N-1) \sin \theta_M}{\lambda}\right) \right],$$

$$i = 1, 2, \dots, M$$

$$X(n) = A(\theta)S(n) + O(n), \quad n = 1, 2, \dots$$

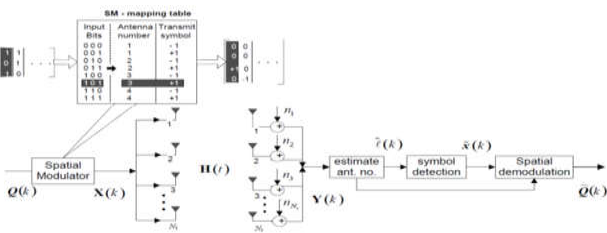

$$A(\theta) = [a(\theta_1), a(\theta_2), \dots, a(\theta_N)]$$



Fig 2 (a) MIMO uses Multipath propagation to exploit link capacity. (b) SM system model.

Proposed Work

In this paper the DOA estimation was carried out using the Least Mean square algorithm(LMS) using the TMS320 32-bit

floating point DSP kit available in our laboratory by tuning the weights of the elements of the reference Array. Before that a comparative study has been performed to lay the foundation of the four Meta-Heuristic Search Algorithms such as GA, SADE, PSO and TM for a 10-element Linear Array by finding an optimum set of weights and antenna element separations. (Amplitude only synthesis). Secondly the PSO algorithm has been compared to GA to test the convergence and effectiveness of the two Algorithms.

The Beamforming techniques used for DSP synthesis has widely been studied here and has been found that Evolutionary Computation far surpasses the performance of Robust Adaptive Beamforming algorithms in terms of both throughput and efficiency.

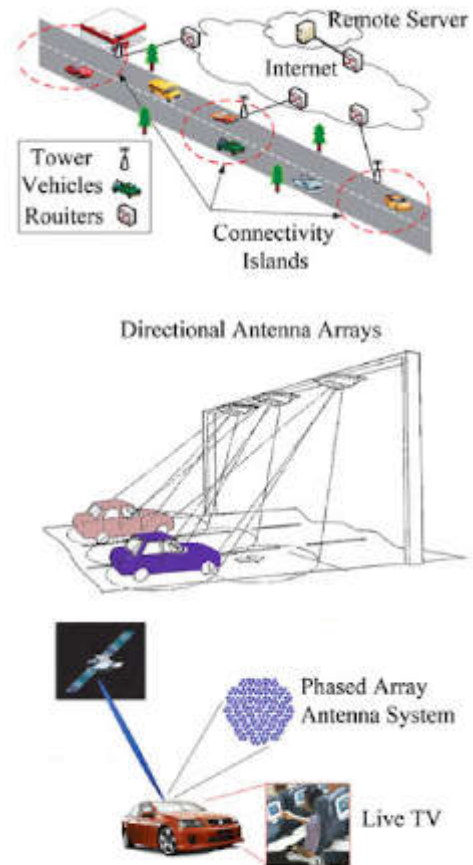

Fig 3 (a) Drive-thru Internet concept. (b) Highway toll collection. (c) DBS-TV.

Comparative study

The Multi Objective cost function used to minimize for Amplitude only synthesis considering the main beam, total beam, sidelobelevel, null control and number of antenna elements with fitness scaling.

$$f(\zeta) = \frac{1}{c_1 f_{BP}(\zeta) + c_2 f_{MB}(\zeta) + c_3 f_{SLL}(\zeta) + c_4 f_{null}(\zeta) + c_5 f_N(\zeta)}$$

$$f_{BP}(\zeta) = \int_{u \in B} (P_{dB}(u)/Q - P_{dB}^{ref}(u)) du$$

$$f_{MB}(\zeta) = \sum_{i=1}^{mb} \left(\int_{u \in MB} (P_{dB}(u)/Q - P_{dB}^{ref}(u)) du \right)$$

$$f_{SLL}(\zeta) = \frac{Q}{\max\{P_{dB}(u)\}} \quad \text{for } u_{start} \leq u \leq 1$$

$$f_{null}(\zeta) = \sum_{i=1}^{ni} \left(\int_{u \in BN_i} (P_{dB}(u)/Q - P_{dB}^{ref}(u)) du \right)$$

$$BN_i = u_{null_i} \pm 0.5 \Delta u_{null_i}$$

$$f_N(\zeta) = M;$$

$$P(u) = \left| \sum_{k=0}^{M-1} w_k e^{j\frac{2\pi}{\lambda} x_k u} \right|$$

$$w_k = \alpha_k \exp(j\beta_k)$$

$$p(u) = \left| \sum_{k=0}^{M-1} \alpha_k e^{j(\frac{2\pi}{\lambda} x_k u + \beta_k)} \right|$$

$$U = \sin(\theta) - \sin(\theta_0)$$

The above equation corresponds to the Array pattern factor for a Linear array for M equally spaced elements.

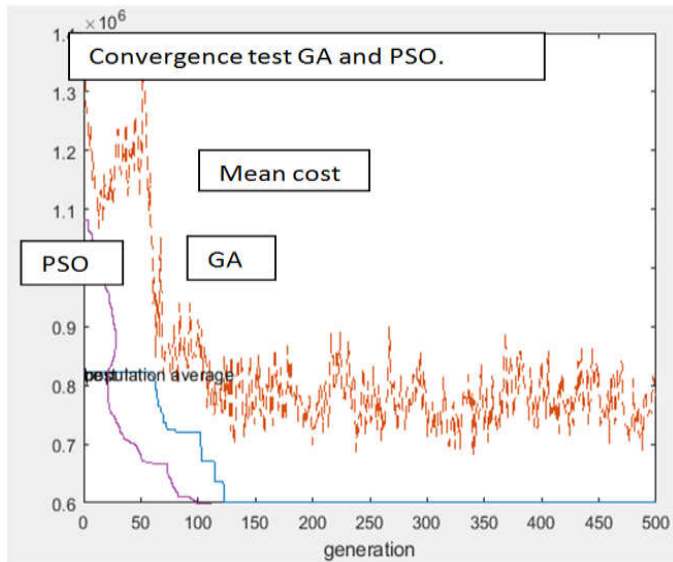
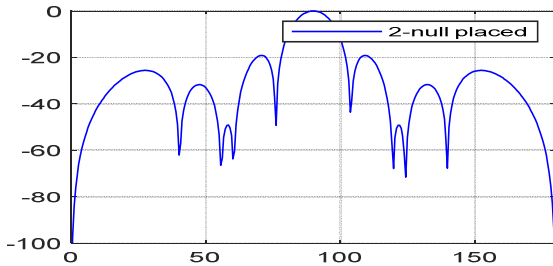
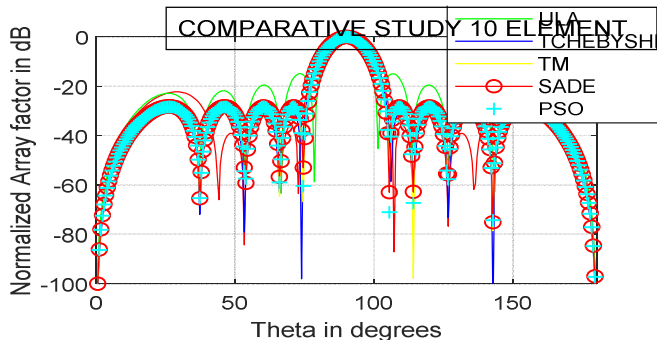

Fig 4 (a) Comparative study 10-element. (b) Array pattern with 2-nulls placed at 60° and 120°. (c) Convergence test.

Table 1 #1 TM-Taguchi's Method

I_N , (current Excitations), 10 elements. No. Of Generations =500, Mutation probability=0.04, Uniform crossover(two point), selection=0.5.

| N | TM | SADE | PSO | Hybrid-BCGA(proposed algorithm) |
|---|--------|--------|--------|---------------------------------|
| 1 | 1.0000 | 1.0000 | 1.0000 | 1.00000 |
| 2 | 0.8999 | 0.9028 | 0.9010 | 0.93333 |
| 3 | 0.7228 | 0.7277 | 0.7255 | 0.68570 |
| 4 | 0.5077 | 0.5153 | 0.5120 | 0.60952 |

| | | | | |
|------------------|--------|--------|--------|---------|
| 5 | 0.3994 | 0.4158 | 0.4088 | 0.37142 |
| SLL(dB) | -24.88 | -24.41 | -24.67 | -26.03 |
| FNBW | | | | 32.12° |
| % | | | | |
| Reduction in SLL | | | | 58.56% |

- #2. SADE-Self-Adaptive Differential Evolution
- #3. PSO-Particle Swarm Optimization.
- #4. H-BCGA-Hybrid Binary Coded Genetic Algorithm.

Chebyshev Array

For the purpose of optimization, the desired Antenna Array was chosen as the Chebyshev Array.

The recursion formulae for chebyshev polynomial is:

$$T_m(z) = 2zT_{m-1}(z) - T_{m-2}(z)$$

$$P_{dB}^{ref} = 2.79 \cos u + 2.49 \cos 3u - 0.97 \cos 5u + 1.35 \cos 7u + \cos 9u$$

- $T_0(x) = 1$
- $T_1(x) = x$
- $T_2(x) = 2x^2 - 1$
- $T_3(x) = 4x^3 - 3x$
- $T_4(x) = 8x^4 - 8x^2 + 1$
- $T_5(x) = 16x^5 - 20x^3 + 5x$
- $T_6(x) = 32x^6 - 48x^4 + 18x^2 - 1$
- $T_7(x) = 64x^7 - 112x^5 + 56x^3 - 7x$
- $T_8(x) = 128x^8 - 256x^6 + 160x^4 - 32x^2 + 1$
- $T_9(x) = 256x^9 - 576x^7 + 432x^5 - 120x^3 + 9x$
- $T_{10}(x) = 512x^{10} - 1280x^8 + 1120x^6 - 400x^4 + 50x^2 - 1$
- $T_{11}(x) = 1024x^{11} - 2816x^9 + 2816x^7 - 1232x^5 + 220x^3 - 11x$

Pascal's Triangle

| | | | | | | | | |
|---|----|----|-----|-----|-----|-----|-----|--|
| | | | | 1 | | | | |
| | | | 1 | 2 | | | | |
| | | 1 | 4 | 4 | | | | |
| | 1 | 6 | 12 | 8 | | | | |
| 1 | 8 | 24 | 32 | 16 | | | | |
| 1 | 10 | 40 | 80 | 80 | 32 | | | |
| 1 | 12 | 60 | 160 | 240 | 192 | 64 | | |
| 1 | 14 | 84 | 280 | 560 | 672 | 448 | 128 | |

Adaptive Beamforming

Adaptive Beamforming is a technique wherein the main beam of the antenna array is steered towards the desired direction and it is steered away from an undesired user even if both the users are operating at the same frequency. This is accomplished by tuning the amplitude perturbations of all the elements in the array. Although signals from different transmitters use the same frequency they may arrive at different angles. This spacial separation is a foundation to Adaptive signal processing. Thomas et al. have developed blind beamforming algorithms. The algorithms possess flexibility to tune the Gains of the main beams of different elements of the array, so as to maximize the gain in a desired direction and minimize the gain in the undesired direction.

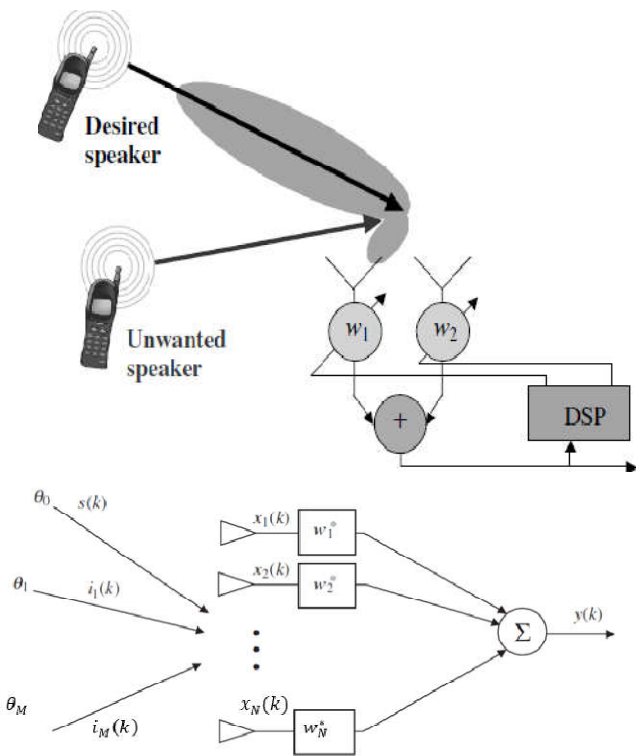

Fig 5 (a) Adaptive Antenna Array. (b) Traditional Beam Former Array

LMS Algorithm with simulation results

1. Assume initial weights are always zero.
2. Find the steering vectors for desired user and Interferer with AWGN noise for the two cases depicted below: -
3. Case1. Desired signal angle=0°. Interferer=40°;
4. Case2. Desired signal angle=30°. Interferer=60°;
5. The array vectors for the interferer a1 and desired user a0 for both the cases is shown below: -
6. Case1. $A1 = [1 \ 0.9993 \ 0.9972 \ 0.9938 \ 0.9889]$;
 $A0 = [1 \ 0.9995 \ 0.9979 \ 0.9954 \ 0.9917]$;
7. Case2. $A1 = [1 \ 0.9999 \ 0.9995 \ 0.9990 \ 0.9989]$;
 $A0 = [1 \ 0.9993 \ 0.9972 \ 0.9938 \ 0.9889]$;
8. Find $X = a0 + a1$. $X = [2 \ 1.9988 \ 1.9951 \ 1.9892 \ 1.9806]$;
 $X1 = [2 \ 1.9992 \ 1.9922 \ 1.9838 \ 1.9870]$;
9. Find the total received signal correlation matrix R_{xx} .

$R =$

| | | | | |
|--------|--------|--------|--------|--------|
| 4.0000 | 3.9976 | 3.9902 | 3.9784 | 3.9612 |
| 3.9976 | 3.9952 | 3.9878 | 3.9760 | 3.9588 |
| 3.9902 | 3.9878 | 3.9804 | 3.9687 | 3.9515 |
| 3.9784 | 3.9760 | 3.9687 | 3.9569 | 3.9398 |
| 3.9612 | 3.9588 | 3.9515 | 3.9398 | 3.9228 |

$\gg R1$

$R1 =$

| | | | | |
|--------|--------|--------|--------|--------|
| 4.0000 | 3.9984 | 3.9844 | 3.9676 | 3.9740 |
| 3.9984 | 3.9968 | 3.9828 | 3.9660 | 3.9724 |
| 3.9844 | 3.9828 | 3.9689 | 3.9521 | 3.9585 |
| 3.9676 | 3.9660 | 3.9521 | 3.9355 | 3.9418 |
| 3.9740 | 3.9724 | 3.9585 | 3.9418 | 3.9482 |

10. Find suitable value of convergence parameter μ .
11. Find the instantaneous total received signal vector $x(k)$.
12. Find the instantaneous array output $y(k)$.

13. Find the instantaneous error signal $e(k)$ between desired array and obtained array vectors.
14. Calculate the weights vectors for next epoch and minimize the cost function $p(k) = \min(E \{ |y(k) - d(k)|^2 \})$.
15. $y(k) = \sum_1^k w_i(k) * x_i(k)$
16. Update weights using the method of steepest descent.
17. Continue till 7000 epochs. Took 7000 epoch to converge to the desired angle.
18. Finally find the array factor.

Frequency used = 2.5 Ghz for the simulation. The simulation was carried out on a DSP 320 series processor with a workstation.

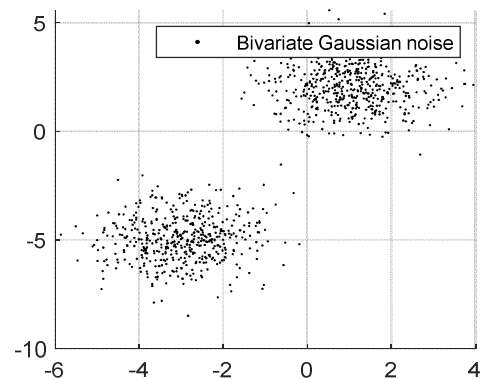
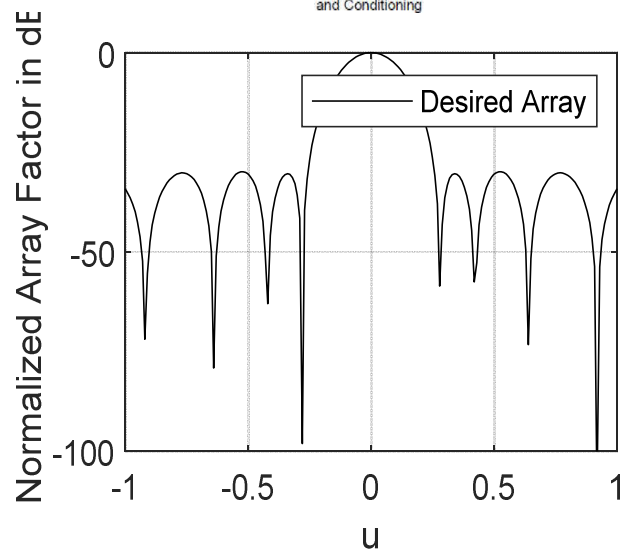
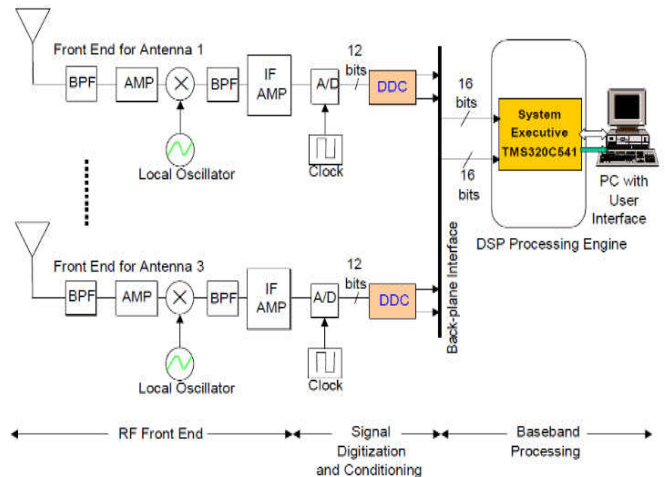

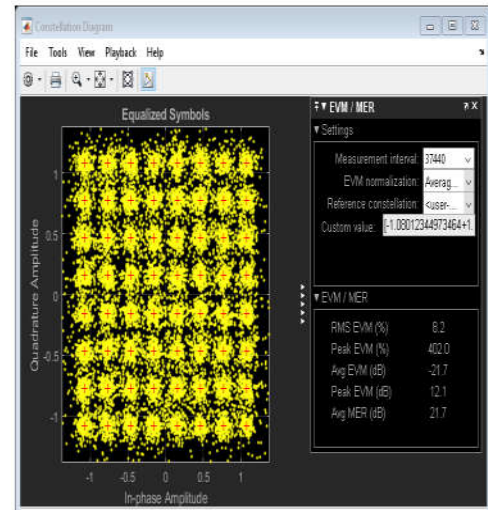
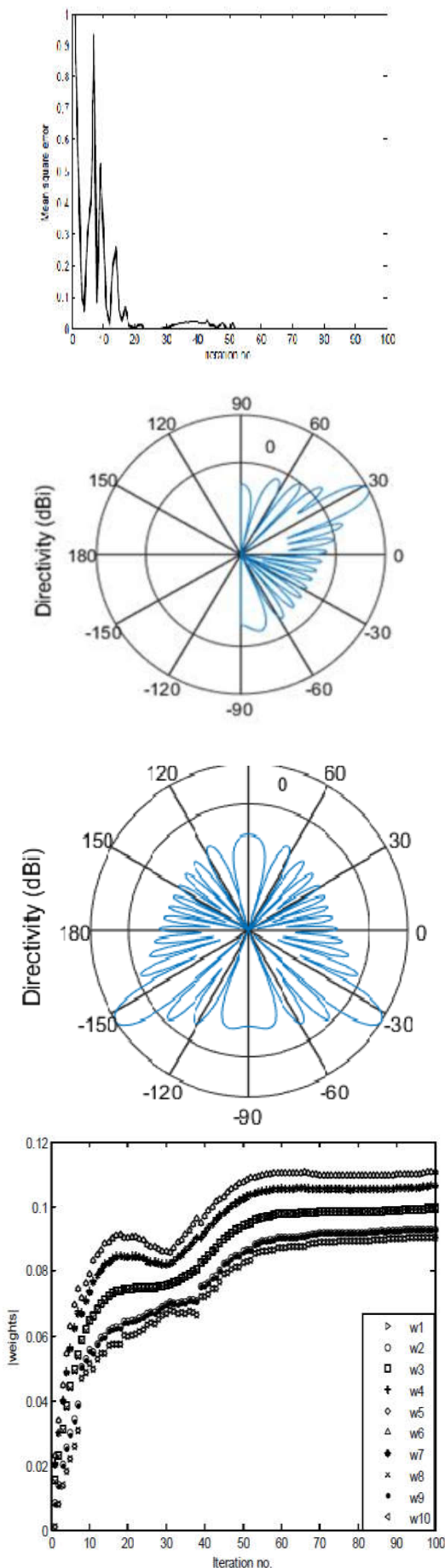

Fig 6 (a) DSP platform for LMS Implementation. (b) Desired -30dB chebyshev array. (c) AWGN noise. (d) MSE convergence. (e) Tx Antenna steering. (f) Rx Antenna steering (Mirror). (g) weight vector variation of LMS Algorithm. (h) Received equalized MIMO constellation or user data QAM after equalization over fading channel.

RESULTS AND DISCUSSIONS

In the initial part of the paper an Array antenna of 10- element was synthesized using Hybrid-GA. The GA parameters were obtained after applying Meta-Heuristic search algorithms to the problem hyperspace. It took about 20 minutes to complete the simulation over a 1 GHz Quad-Core Pentium Processor with RAM expanded to 4GB. Popsiz=128; mutation probability=0.04; number of bits=10; no. of generations=500.

#1. Simulation Results: -

Date and estimated time=08-Jul-2018 19:32:37

optimized function is testfunction1

pop size = 128 mutrate = 0.04 # par = 5

#generations=500 best cost=9996.7969

best solution

1.0264 0.95797 0.70381 0.62561 0.38123

binary genetic algorithm

each parameter represented by 10 bits

For the second case, we performed a quick study on the TMS320 kit initially to perform adaptive beamforming of a 10-element antenna array. For the 1st 100 epochs the fit could not converge. The fit converged after 7000 epochs and exact results were obtained on a Lenovo workstation interfaced with the same TMS320 series 32 bit DSP kit with code composer studio and Matlab R2018a Phased Array system toolbox. The operating system used was windows 8.1 64-bit.

CONCLUSIONS

A novel Genetic Algorithm has been tested considering a static environment but improvement is required for testing this algorithm in dynamic Real time environments. Adaptive beamforming using the DSP LMS Algorithm has been implemented successfully. In future, we hope to develop other Robust evolutionary algorithms which have advantage over present day beamforming algorithms.

At present we are working on conformal arrays which has remained as our proposed work from the past few years of my research career.

References

1. Antenna Theory, Analysis and Design by Constantine A. Balanis.
2. Wireless Communication and Networks, 3G and beyond by I.Saha. Misra.
3. Beamforming: sensor signal processing for Defence Applications by Manikas Athana.
4. Introduction to Space-Time Wireless Communications by Arogyaswami Paulraj, Rohit Nabar and Dhanajay Gore.
5. Weight Optimization for Adaptive Antenna Arrays using LMS and SMI Algorithms by M. Al Sadoon, Raed A Abd, WSEAS transactions on Communications.
6. Implementation of an Adaptive Antenna Array using the TMS320C541, KimPhillips, ZhongHu, Application Report, Spr32.
7. Application of Particle Swarm Optimization Algorithm in Smart Antenna Array Systems by May M.M. Wajih and Hassan M Elkamclouch, AlexandriaUniversity, faculty of Engineering, Egypt.

How to cite this article:

Joyanto Roychoudhary *et al* (2018) 'Linear Antenna Array Adaptive Beamforming for Space-Time Signal Processing Using Hybrid Genetic Algorithms Applied to Fading Channels', *International Journal of Current Advanced Research*, 07(7), pp. 14358-14363. DOI: <http://dx.doi.org/10.24327/ijcar.2018.14363.2602>
